

Data Sheet

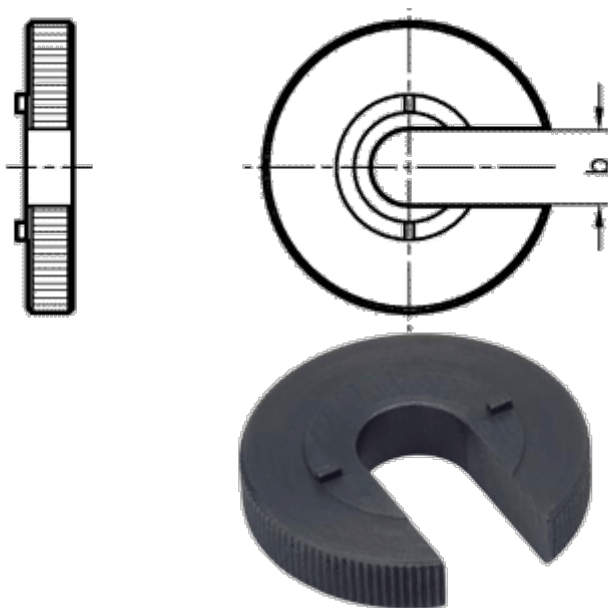

Article number: 20892002
Description: E+G Tool for GN 613
GN 613.1-6

Measures



b = 6 mm